

Particulate matter – monitoring during end milling under different cooling-lubrication strategies

M.S. Kasim^{1,2,*}, N.H.N. Husshini^{1,2}, M.S.A. Hafiz^{1,2}, W.N.F.Mohamad^{1,2,4}, R.Izamshah^{1,2}, J.A Ghani³, and C.H.C Haron³

¹ *Fakulti Kejuruteraan Pembuatan, Universiti Teknikal Malaysia Melaka, 76100, Hang Tuah Jaya, Melaka, Malaysia*

² *Advanced Manufacturing Centre, Universiti Teknikal Malaysia Melaka, 76100, Hang Tuah Jaya, Melaka, Malaysia*

³ *Faculty of Engineering and Built Environment, Universiti Kebangsaan Malaysia, 43600, Bangi, Selangor, Malaysia*

⁴ *Fakulti Rekabentuk Inovatif dan Teknologi, Universiti Sultan Zainal Abidin, 21300, Kuala Terengganu, Terengganu, Malaysia*

* *Corresponding author. E-mail: shahir@utem.edu.my*

Received: Nov. 22, 2020, Accepted: Mar. 11, 2021

Many lubrication strategies have been applied in cutting processes. The main purpose is to reduce heat generated and to lower friction on the cutting tool thus improving the surface quality of the workpiece. However, the quality of indoor air has become a major health and safety issue. This study explains the effects of cooling, lubrication strategies and cutting parameters on particulate matter emission. The experiments involved the use of TiCN CVD coated carbide with varying cutting speeds (Vc), feed rates (fz), and cooling-lubrication strategies (dry, chilled air, chilled MQL, MQL, flood-coolant and pulsating lubrication) for both Aluminium alloy 6061 and Inconel 718. Design of experiment and analysis of variance (ANOVA) were used to examine the effects of the input parameters on the PM_{2.5} value. Based on ANOVA, it was found that the chilled MQL and MQL exhibited high PM_{2.5} readings, while the other coolant strategies yielded results which were within an acceptable exposure limit.

KEYWORDS: Particulate Matter; End milling; Eco-friendly Cooling-lubrication strategy; Aluminium alloy 6061; Inconel 718

© The Author(s). This is an open access article distributed under the terms of the [Creative Commons Attribution License \(CC BY 4.0\)](https://creativecommons.org/licenses/by/4.0/), which permits unrestricted use, distribution, and reproduction in any medium, provided the original author and source are cited.

[http://dx.doi.org/10.6180/jase.202112_24\(6\).0010](http://dx.doi.org/10.6180/jase.202112_24(6).0010)

1. Introduction

Metal cutting is the most widely used process in various sectors of manufacturing. Aluminium alloy 6061 (al-alloy 6061) grade is broadly utilise in various fields of aerospace, automotive, petrochemical, marine, electrical, domestic products, etc. owing to its medium-to-high strength, availability, low cost and high strength-to-weight ratio [1]. Inconel 718 is use in a variety of jet engine components and high-speed air frame parts due to its good mechanical and chemical resistance properties [2], which is why this material is commonly used in harsh environments. The drawback of having these

good properties is that these materials are hard to machine. The abrasiveness of the carbide particles and poor conductivity causes extreme heat to be produced at the vicinity of the cutting region which is prone to producing excessive heat and wear on the cutting tool [3]. Wear mechanisms such as diffusion, adhesion, and abrasive wear are associated with poor cooling and lubricating effects on the cutting tool [4].

Many investigations have been carried out to identify the best solutions to reduce cutting temperature and to improve lubrication. The application of conventional flood-coolant raised the question of handling cost, health problems for the machinist and environmental issues during disposal [5, 6].

Some new strategies for cooling and lubrication have been widely explored and studied such as minimum quantity lubrication (MQL), cryogenic process, intermittent lubrication, etc. These strategies have emerged as sustainable manufacturing techniques. Najiha et al. [7] investigated the MQL solution during machining of AL 6061 T6. The viability of a new approach in improving the machinability of aluminium alloy 6061 using a pulsation strategy was investigated by Hafiz et al. [8]. Hadi et al. [9] studied the effect on machinability during sub-zero temperature end milling of Inconel 718. Sulaiman et al. [10] used MQL during the turning process. These findings have been very promising in terms of prolonging of tool life and improvement of surface integrity.

Nowadays, sustainability in cutting processes is of paramount importance. The issue is not only related to soil contamination during coolant disposal but also related to particulate matter emission ($PM_{2.5}$) during cutting operations. However, there is a lack of information related to $PM_{2.5}$ from literature. This is very important since numerous epidemiological studies have linked $PM_{2.5}$ with significant health problems [11]. Particulate matter (also called particle solution) refers to fine particles or droplets in the air which have a diameter or width of less than 2.5 micrometres. This size is 3% of the diameter of a human hair [12].

Based on US EPA regulations, the average daily limit exposure for particle pollution is $35 \mu\text{g}/\text{m}^3$ [13]. Studies done by R. Miller showed that the cardiovascular system encounters dysfunctional problems when exposed to air pollution [14]. Severity rating of revised $PM_{2.5}$ air quality index (AQI) can be segregated into six clusters: 0-50 is consider good, 51-100 is moderate, 101-150 is unhealthy for certain sensitive groups, 151-200 is unhealthy, 201-300 is very unhealthy and 300+ is deemed to be hazardous [15].

In the cutting process, the source of pollution comes from the material debris, fog from cutting fluid vaporization and mist from MQL as well as flood-coolant [16]. In these operations, health concerns and cost are important issues for achieving environmental sustainability in manufacturing [17]. During MQL, the mist turns into small particles. These particles can be broken into micro sizes like a "Uranium chain reaction". As human pores are micro-sized, if the particles come into contact with the skin, they can enter then cause various problems to the skin and lungs. A study among machinists exposed to cutting fluids have shown increased rates of cough and phlegm, shortness of breath and skin cancers [18].

Djebara et al. [19] had investigated the effects of cutting of titanium alloy on the $PM_{2.5}$ emission during slot milling under dry conditions. Based on the input parameter, they reported that tool type was dominating the particulate matter emission, followed by interaction between cutting speed and feed rate. There are high concerns that cutting fluids can pose significant health, safety, and environmental hazards. Approximately 80% of all occupational diseases are reported to be associated with skin contact with cutting fluids [20].

The main objective of this paper is to investigate the effects of lubrication methods toward eco-friendly cutting processes by using $PM_{2.5}$ as indicator. This experimental study conducted in end-milling process with ball end mill under varied machining parameters (cutting speed, feed rate and material). $PM_{2.5}$ reading was recorded to evaluate the effect of the lubrication method and machining parameter on the air quality.

2. Experimental procedures

2.1. Materials and cutting tool

The experiments were performed on al-alloy 6061 and Inconel 718. Table 1 and Table 2 show the chemical compositions for al-alloy 6061 and Inconel 718. The alloys were supplied in rectangular block form with measurements of $135 \times 101 \times 38$ mm and $171 \times 95 \times 41$ mm respectively. The selections were based on the machinability index of these materials, which were 3.2 and 0.16 respectively. Both materials have gummy properties, so the $PM_{2.5}$ value does not significantly affect the material. The hardness of Aluminium was 103 HV and the hardness for Inconel was 350 HV after testing them on a Rockwell hardness tester (Series 810). The insert was TiCN CVD coated carbide (ACK200 grade) from Sumitomo. A $6 \mu\text{m}$ of coating thickness with an insert with diameter of 10 mm was attached to the 20 mm diameter WRCX-E tool holder. The tool was constantly overhung at 50 mm with the values of axial and radial runout at $15 \mu\text{m}$ and $30 \mu\text{m}$ throughout the experiments.

2.2. Experimental set-up

The experiments were conducted on a HAAS CNC 3-axis milling machine with maximum speed of 7500 rpm and feed rate of 12,700 mm/min. The cutting parameter setting was as summarized in Table 3, while Figure 1 demonstrated the experimental set-up. Room temperature was 26°C while humidity was 91%. During the experimentation, PPE was used as a safety measure and the machine's door was closed to

Table 1. Chemical composition of Aluminium alloy 6061 [21].

Element	Mg	Si	Fe	Cu	Cr	Zn	Ti	Mn	Al
Wt%	0.81	0.64	0.32	0.22	0.18	0.02	0.02	0.01	Balance

Table 2. Chemical composition of Inconel [22].

Element	Ni	Fe	Cr	Nb	Ta	Mo	Ti	Al	Co	Mn
Wt%	53	18.7	18.3	5.05	3.05	1.05	0.49	0.30	0.23	
Element	Si	C	Cu	B	P	S				
Wt%	0.08	0.051	0.04	0.004	<0.005	<0.002				

prevent escape of particle emissions during the metal cutting process. The laboratory was equipped with a ventilator.

The machining was done with the slot milling process with a total of 12 runs, where there were 6 runs each for the al-alloy 6061 and the Inconel 718. Bechem Avantin 341 was used as the cutting fluid under chilled MQL, MQL, flood-coolant and pulsating lubrication conditions (Figure 2). The coolant concentration was maintained at $5 \pm 0.2\%$ brix which was measured with an Atago Master- α refractometer. The chilled air was prepared by using a NEX FLOW vortex tube (Model 58208) with an average nozzle temperature of 10°C . The vortex tube was capable of producing mist by connecting the lubrication tube to the vortex system (Figure 3).

Table 3. Experimental plan.

Cutting speed, V_c	100-120 m/min
Feed rate, f_z	0.1 - 0.2 mm/tooth
Cooling-lubrication strategy	Dry
	Chilled Air
	Chilled MQL
	MQL
	Flood-coolant
Material	Pulsating lubrication
	Aluminium alloy 6061 Inconel 718

A particulate matter $\text{PM}_{2.5}$ detector tester meter as shown in Figure 4 was used to monitor air quality. The device was controlled by an Advanced RISC Machines (ARM) 32-bit processor for accurate detection and system fluency. It was capable of measuring multi-range air quality in $\text{PM}_{1.0}$, $\text{PM}_{2.5}$, $\text{PM}_{10.0}$ with an accuracy of ± 0.1 . The air quality monitor was placed 1 meter from the cutting region. The maximum reading value was taken during machining time and classified

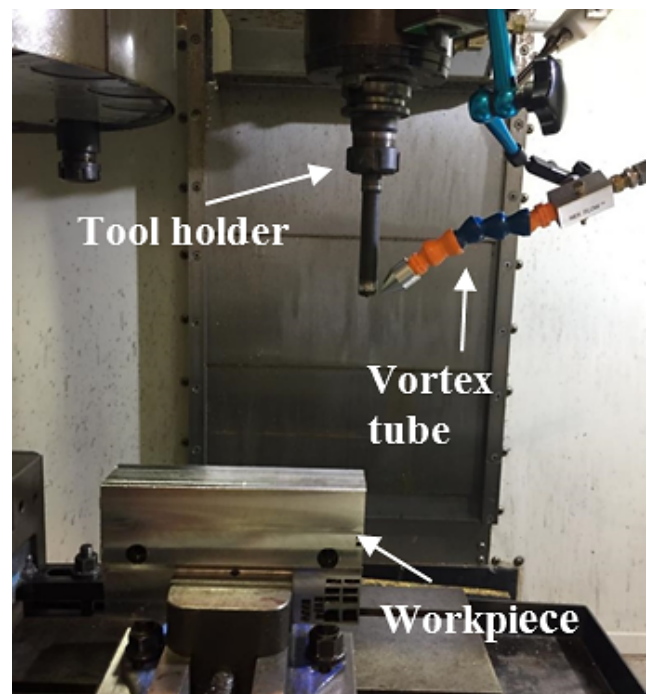
**Fig. 1.** Set-up of experimental configuration.

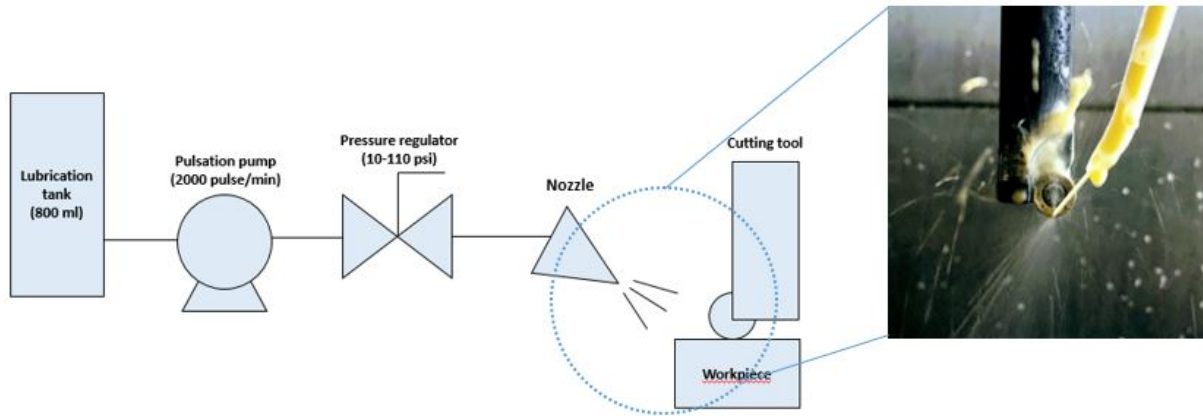

Fig. 2. Pulsating lubrication experiment strategy.

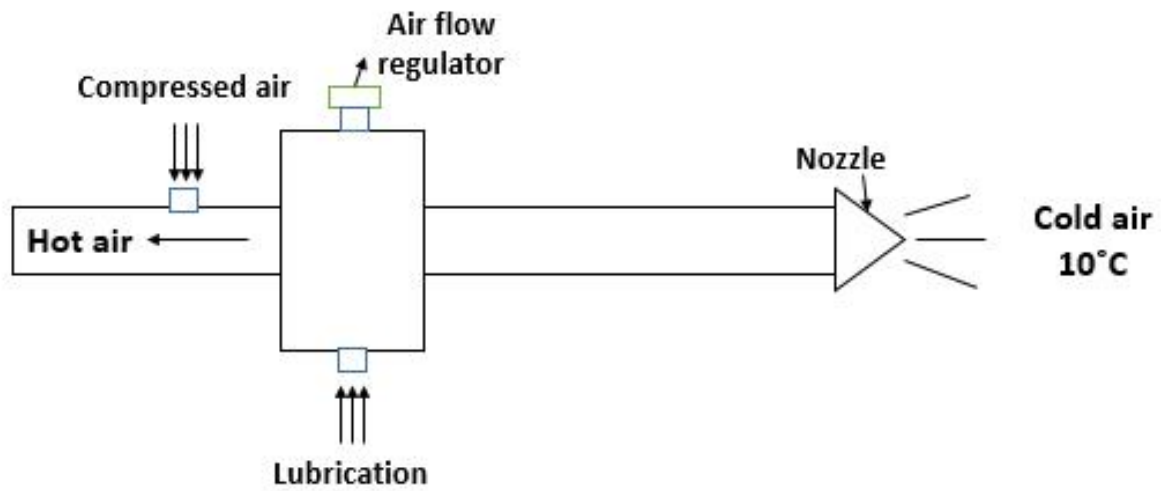

Fig. 3. Vortex tube workflow.

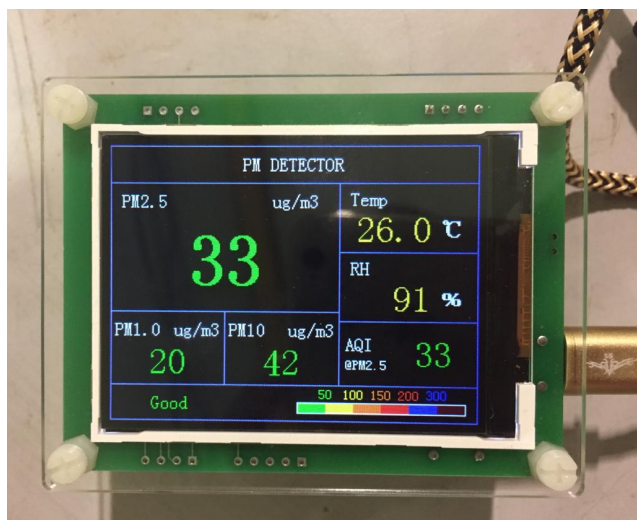

Fig. 4. Particulate matter PM_{2.5} detector.

based on National Ambient Air Quality Standards (NAAQS) to identify the severity rating of PM_{2.5} air quality condition (Table 4).

Data collected was then analyzed using Analysis of Variance (ANOVA) from Design Expert Software version 10 through the historical data method. The p-value was used to determine the most significant factor affecting the quality of air during the machining process. The p-value was not to exceed the alpha value of 0.05 which represented the confidence level of the results.

3. Results

3.1. PM_{2.5} detection results

This section discusses the results obtained from the experiment. The objective of the present work was to investigate the effects of input parameters on the PM_{2.5} under six different cooling-lubrication strategies: dry, chilled air, chilled MQL, MQL, flood-coolant and pulsating lubrication. The results of the experiment have been summarized in Table 5.

3.2. Analysis of Variance (ANOVA)

Table 6 shows the ANOVA result by employing the linear model. This selected model is significant due to the P-value and F-value of the model, of 0.0001 and 1549.04 respectively. According to the ANOVA, the cooling-lubrication strategy (C) is the only significant factor at 0.0001 (P-value) with the F-value of 1745.64. The rest of cutting speed (A), feed rate (B) and material type (D) were found to be insignificant with the

p-value exceeding 0.05. The fitness model was confirmed by R² and the adjusted R² valued of 0.9998 and 0.9991 respectively. Meanwhile, the adequate precision value of 90.090 indicated that the signal-to-noise ratio exceeded 4, which was considered to be desirable.

3.3. Response graph

Interaction plots as shown in Figure ?? illustrated the effect of cutting speed, Vc and cooling-lubrication strategy on the PM_{2.5}. It was found that the Vc followed a similar trend and gradient for each of the cooling-lubrication strategies over the PM index. An increase in Vc resulted in a decrease in PM_{2.5} value, thereby implying better air quality. However, the response surface graph (Figure 6) demonstrated the insignificant factors on the interaction of the Vc, and fz (feed rate). It appeared that the quality of the air was not influenced by minimum and maximum Vc range, which were 100 m/min and 140 m/min respectively. The results were in agreement with Djebara et al. [19], who clearly found that the dust emission size remained the same even with the increment of Vc. The effects of cooling-lubrication strategy could also be clearly observed.

Figure 7 shows the effect of PM_{2.5} for six coolant-lubrication strategies. It was observed that the use of chilled MQL and MQL resulted in higher emissions of particulate matter. The results of using the other strategies fell under "moderate" and "unhealthy to certain groups". Therefore, when MQL was used, the mist of the coolant was considered to be an undesirable sub-product since they caused an increase in air pollution. This finding may be attributed to the fact that mist coolant yields higher particle concentrations in ambient air. These were consistent with the study conducted by Mia et al. [23]. This ambient emission particle can induce short-term effects of discomfort such as irritation to the throat, skin, eyes and nose. However, with long-term exposure, this can lead to serious health problems, especially to the human respiratory system. Unfortunately, rigid studies of the relational effect of particles on the health of people during the machining process have been less reported in academic literature.

Based on these plots, it was noticed that the dry and chilled air conditions resulted in the lowest PM during the machining process. This is because the process merely on cooling process without lubrication sprayed. This appeared to show that chilled air and dry conditions are good candidates for a sustainable approach in terms of air quality. In term of cutting

Design-Expert® Software
Factor Coding: Actual
PM2.5 AQI

X1 = A: Vc
X2 = C: Cooling-lubrication strategy

Actual Factors
B: fz = 0.15
D: Material = Average over

■ C1 Dry
▲ C2 Flood-coolant
◆ C3 Chilled air
⊕ C4 Chilled MQL
× C5 MQL
⋈ C6 Pulsating lubrication

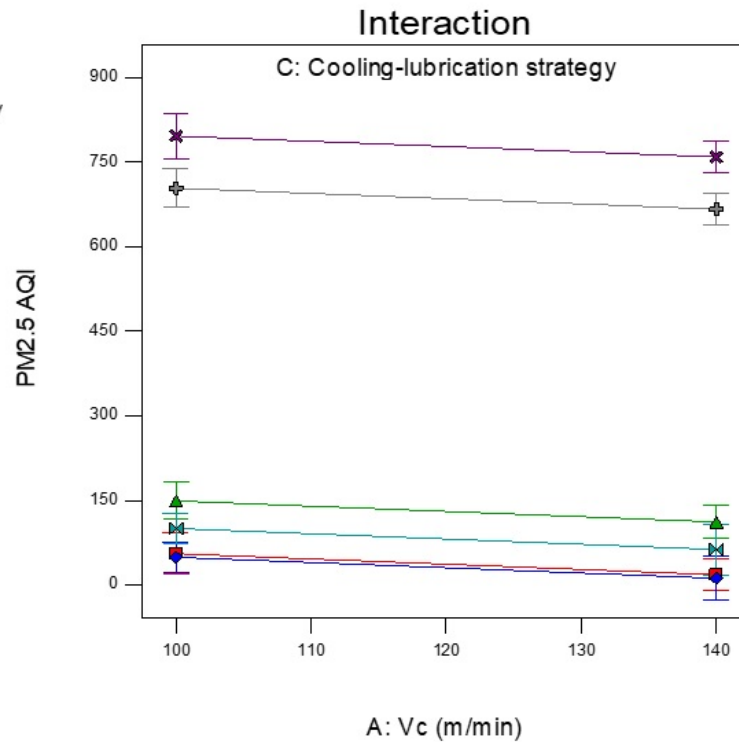

Fig. 5. The effect of cutting speed on particulate material emission for different cooling-lubrication strategies.

Table 4. Breakpoints for PM_{2.5} Sub-Index [15].

AQI Category	Index values	Proposed breakpoints ($\mu\text{g}/\text{m}^3$, 24-hour average)
Good	0–50	0.0–12.0
Moderate	51–100	12.1–35.4
Unhealthy for Sensitive Groups	101–150	35.5–55.4
Unhealthy	151–200	55.5–150
Very Unhealthy	201–300	150.5–250.4
Hazardous	301–400	250.5–350.4
	401–500	350.5–500.4

process, however, these strategies are not preferable due to poor cooling effect at the work tool interface. From the experiment., the cutting process involved lubrication droplet spray (MQL and Chilled MQL) cause high pollution level (PM_{2.5} > 600) which fall under Hazardous AQI index. This phenomenon causes by the lubrication stream was transformed into scattered smaller droplet diameters with the higher spray flows by the conical spray tip nozzle. Only few was targeted to the cutting tool while the remaining mist disperse to the

airborne.

Another approach of flood-coolant and pulsating lubrication appear to be more feasible sustainability strategies compared to the others (dry, chilled air, MQL, chilled MQL). From the graph in Figure 7, it shows the reading of AQI index was less than 150 showing less contamination to the airborne. Besides, these methods also provide good lubrication, effective heat dissipation and friction reduction during material removal process.

Table 5. Comparison among PM_{2.5} values for different cooling-lubrication strategies.

Exp No.	Vc (m/min)	fz (mm/tooth)	Cooling-lubrication strategy	Material	PM _{2.5} AQI	Air quality condition
1	120	0.1	Dry	Al-alloy 6061	40	Good
2	120	0.2	Flood-coolant	Al-alloy 6061	135	Unhealthy for certain groups
3	100	0.2	Chilled air	Al-alloy 6061	52	Moderate
4	100	0.1	Chilled MQL	Al-alloy 6061	712	Extremely hazardous
5	120	0.1	MQL	Al-alloy 6061	796	Extremely hazardous
6	100	0.2	Pulsating lubrication	Al-alloy 6061	103	Unhealthy for certain groups
7	120	0.15	Dry	Inconel 718	36	Good
8	120	0.15	Flood-coolant	Inconel 718	125	Unhealthy for certain groups
9	100	0.1	Chilled air	Inconel 718	47	Good
10	140	0.2	Chilled MQL	Inconel 718	659	Extremely hazardous
11	120	0.1	MQL	Inconel 718	763	Extremely hazardous
12	100	0.2	Pulsating lubrication	Inconel 718	95	Moderate

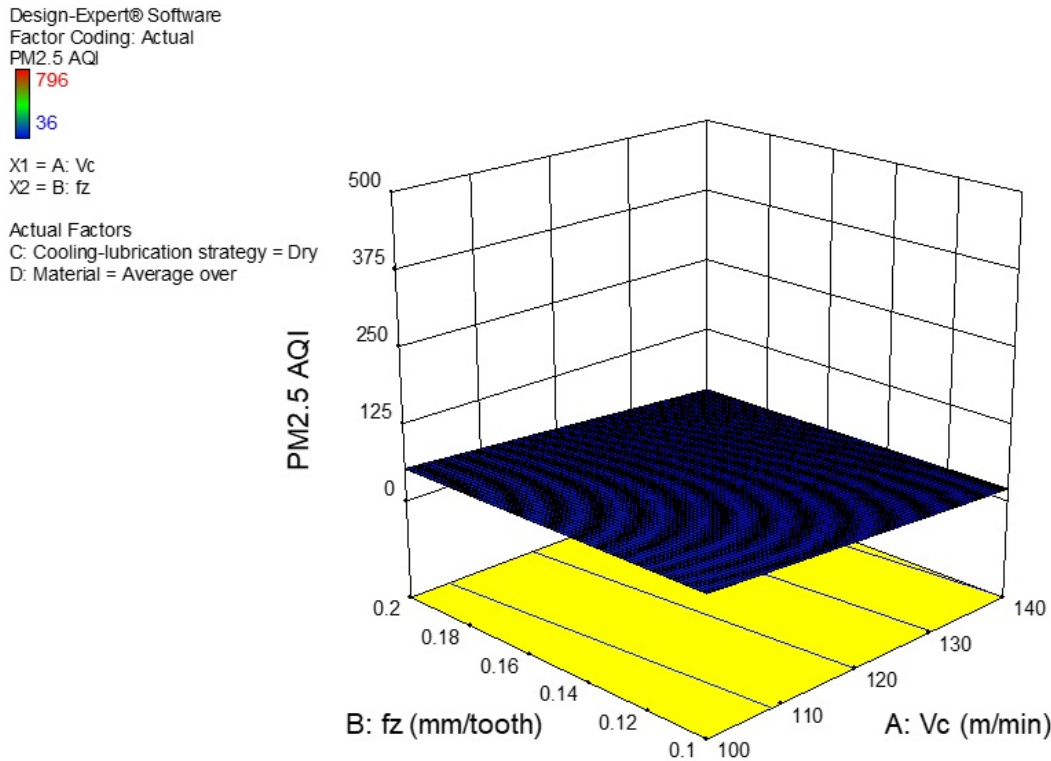

Fig. 6. The response surface graphs showing the non-significant effects of both cutting speed and feed rate on particulate material emission.

4. Conclusions

Readings of PM_{2.5} were collected during the milling process of Aluminium alloy 6061 and Inconel 718. The important

findings throughout the process are as given below: • Based on ANOVA analysis, cooling-lubrication strategy was shown to be a significant factor due to the p-value < 0.05 which proved that cutting speed, feed rate and materials do not

Table 6. ANOVA table indicating the main effect of PM_{2.5} value.

Source/Factor	Sum of Squares	DF	Mean ²	F-value	P-value	
Model	1.16 × 10 ⁶	8	1.45 × 10 ⁵	1549.04	<0.0001	significant
A	301.57	1	301.57	3.22	0.1706	
B	6.15	1	6.15	0.066	0.8142	
C	8.17 × 10 ⁵	5	1.63 × 10 ⁵	1745.64	<0.0001	significant
D	344.82	1	344.82	3.68	0.1508	
Residual	280.85	3	93.62			
Cor Total	1.16 × 10 ⁶	11				

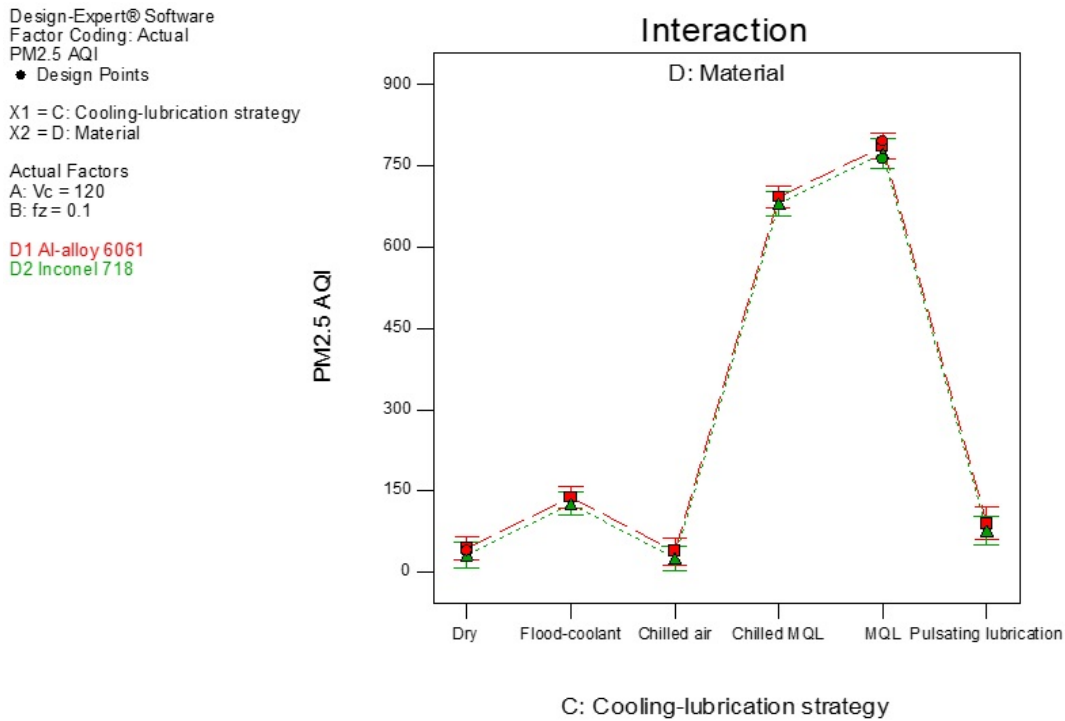
**Fig. 7.** The effect of cooling-lubrication on PM_{2.5} for aluminium and Inconel 718 material.

highly impact the air quality. • Chilled MQL and MQL strategies had the highest reading of PM_{2.5} due to higher emission of particulate matter, followed by flood-coolant, pulsating, dry and chilled air strategies. • Based on the results, cutting processes under flood-coolant and pulsating strategies will be significantly beneficial in terms of clean processing, which promotes the machining cooling-lubrication in terms of sustainability. Future work will include the influence of biodegradable and non-toxic oil on air quality. Additionally, surface integrity and cutting force will be analyzed in future study. This experimental study also can be conducted in

drilling and turning process.

Acknowledgements

This work is an outcome of research and scientific activities of Advanced Manufacturing Center, Fakulti Kejuruteraan Pembuatan, Universiti Teknikal Malaysia Melaka. Special thanks to students 1BMMI S1/1, Fakulti Teknologi Kejuruteraan Mekanikal dan Pembuatan for collecting valuable data. This research was funded by grant from Ministry of Higher Education Malaysia (Grant no: FRGS/2018/FKP-AMC/F00378) and Fakulti Kejuruteraan Pembuatan of Universiti Teknikal

Malaysia Melaka (JURNAL/2019/AMC/Q00043).

References

- [1] Adhip Shukla, Aman Kotwani, and Deepak Rajendra Une. Performance comparison of dry, flood and vegetable oil based minimum quantity lubrication environments during CNC milling of Aluminium 6061. In *Materials Today: Proceedings*, volume 21, pages 1483–1488. Elsevier Ltd., 2020. .
- [2] Mohd Asyraf Mahboob Ali, Azwan Iskandar Azmi, and Ahmad Nabil Mohd Khalil. Specific cutting energy of Inconel 718 under dry, chilled-air and minimal quantity nanolubricants. In *Procedia CIRP*, volume 77, pages 429–432. Elsevier B.V., 2018. .
- [3] Alborz Shokrani and Stephen T. Newman. Hybrid cooling and lubricating technology for CNC milling of Inconel 718 nickel alloy. In *Procedia CIRP*, volume 77, pages 215–218. Elsevier B.V., 2018. .
- [4] D. Dudzinski, A. Devillez, A. Moufki, D. Larrouquère, V. Zerrouki, and J. Vigneau. A review of developments towards dry and high speed machining of Inconel 718 alloy. *International Journal of Machine Tools and Manufacture*, 44(4):439–456, 2004. ISSN 08906955. .
- [5] G. Byrne and E. Scholta. Environmentally Clean Machining Processes - A Strategic Approach. *CIRP Annals - Manufacturing Technology*, 42(1):471–474, jan 1993. ISSN 17260604. .
- [6] S. Y. Hong and M. Broomer. Economical and ecological cryogenic machining of AISI 304 austenitic stainless steel. *Clean Products and Processes*, 2(3):0157–0166, nov 2000. ISSN 1618954X. .
- [7] M. S. Najiha, M. M. Rahman, and K. Kadirgama. Machining performance of aluminum alloy 6061-T6 on surface finish using minimum quantity lubrication. *International Journal of Automotive and Mechanical Engineering*, 11(1): 2699–2712, 2015. ISSN 21801606. .
- [8] M. S.A. Hafiz, M. S. Kasim, R. Izamshah, W. N.F. Mohamad, A. Abdullah, and M. F. Jaafar. An assessment for a new approach to pulsating lubrication strategy (PLS) in end milling. *International Journal of Advanced Manufacturing Technology*, 105(7-8):3157–3163, 2019. ISSN 14333015. .
- [9] M. A. Hadi, J. A. Ghani, C. H. Che Haron, and M. S. Kasim. Investigation on wear behavior and chip formation during up-milling and down-milling operations for inconel 718. *Jurnal Teknologi (Sciences and Engineering)*, 66 (3):15–21, 2014. ISSN 01279696. .
- [10] M.A. Sulaiman, M.S. Asiyah, R. Shahmi, E. Mohamad, N.A. Mohamad, M.A. Md Ali, D. Yuniawan, and T. Ito. Effect of Cutting Parameter on the Tool Life of the uncoated carbide tool during turning using Minimum Quantity Lubrication (MQL). 2017.
- [11] Yaolin Lin, Jiale Zou, Wei Yang, and Chun Qing Li. A review of recent advances in research on PM2.5 in China, 2018. ISSN 16604601.
- [12] San Salvador and El Salvador. Overview of Particle Air Pollution (PM2.5 and PM10), 2012. URL <https://www.epa.gov/sites/production/files/2014-05/documents/huff-particle.pdf>.
- [13] Robert W. Kolb. National Ambient Air Quality Standards (NAAQS). In *The SAGE Encyclopedia of Business Ethics and Society*, number 4, pages 1–2. SAGE Publications, Inc., 2455 Teller Road, 2018. .
- [14] United States Environmental Protection Agency. No Title. URL <https://www.epa.gov/sites/production/files/2015-02/documents/criteria.pdf>.
- [15] Final Rule. National Ambient Air Quality Standards. Part II AGENCY. 78(10), 2013.
- [16] Ellen A Eisen, Thomas J Smith, David Kriebel, Susan R Woskie, Douglas J Myers, Susan M Kennedy, Stuart Shalat, and Richard R Monson. Respiratory health of automobile workers and exposures to metal-working fluid aerosols: Lung spirometry. *American journal of industrial medicine*, 39(5):443–453, 2001.
- [17] I. P. Okokpujie, C. A. Bolu, O. S. Ohunakin, E. T. Akinlabi, and D. S. Adelekan. A review of recent application of machining techniques, based on the phenomena of CNC machining operations. In *Procedia Manufacturing*, volume 35, pages 1054–1060. Elsevier B.V., 2019. .
- [18] Kun Li, Fereydoun Aghazadeh, Selen Hatipkarasulu, and Thomas G. Ray. Health risks from exposure to metal-working fluids in machining and grinding operations. *International Journal of Occupational Safety and Ergonomics*, 9(1):75–95, jan 2003. ISSN 10803548. .
- [19] Abdelhakim Djebara, Victor Songmene, and Ali Bahloul. Effects of machining conditions on specific surface of PM_{2.5} emitted during metal cutting. *Health*, 05(10):36–43, 2013. ISSN 1949-4998. .
- [20] HSE BOOK. Medical aspects of occupational skin disease. 24:1–17, 2004.
- [21] A.-M. El-Batahgy, B. Terad, and A. Omar. Effect of fric-

tion stir welding parameters on properties of AA6061 aluminum alloy butt welded joints. In *Proceedings of the 1st International Joint Symposium on Joining and Welding*, pages 33–40. Elsevier, 2013. .

- [22] A. H. Musfirah, J. A. Ghani, and C.H. H.Che Haron. Tool wear and surface integrity of inconel 718 in dry and cryogenic coolant at high cutting speed. *Wear*, 376-377: 125–133, apr 2017. ISSN 00431648. .
- [23] Mozammel Mia, Munish Kumar Gupta, Gurraj Singh, Grzegorz Królczyk, and Danil Yu Pimenov. An approach to cleaner production for machining hardened steel using different cooling-lubrication conditions. *Journal of Cleaner Production*, 187:1069–1081, jun 2018. ISSN 09596526. .